



NewTom 5G XL



Sede legale ed amministrativa - Headquarters
QR srl - Via Selice Provinciale, 23/a - 40026 Imola - Bo (Italy)
Stabilimento - Plant
Via Fermi, 40 - 37136 Verona (Italy)
Tel. +39 045 8202727 - 045 583500
info@newtom.it www.newtom.it

Cone Beam 3D Imaging
NewTom
what's next

THE DNA OF A LEADER.

Latest-generation technology

Patented innovations

Maximum image quality

Broadened diagnostic capacity

Optimal workflow

Specialist software

Attention to patient health

Minimum X-ray doses

THE MASTERMIND OF CBCT IMAGING

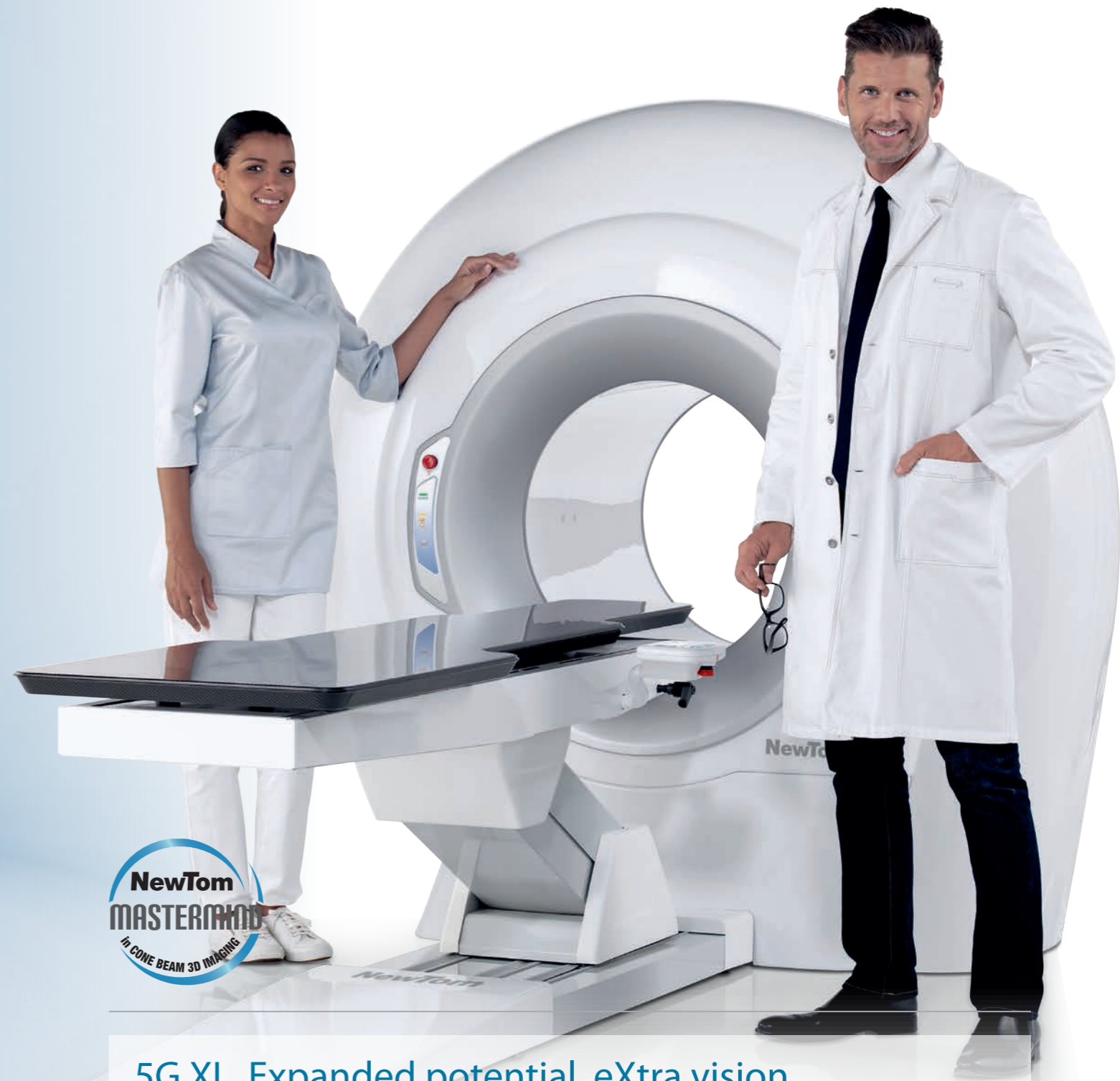

5G XL. Expanded potential, eXtra vision

The NewTom 5G XL - the device that extends the very best CBCT technology to new fields of application in medicine - has arrived. The 5G XL is the only system with a motorized patient table that combines high diagnostic resolution with minimum patient exposure. Extra potential for radiologists and specialist physicians.



UNEQUALLED PROSPECTS

The NewTom 5G XL is the only CBCT with the patient in a lying down position that guarantees a combination of minimum X-ray exposure and unparalleled 3D image definition. It also allows 2D and X-ray video imaging. NewTom has now exceeded the limits posed by CT systems.

Better diagnostic quality

Maximum-definition 3D examinations with multiple FOVs and 2D examinations. The first CBCT with a wide native 21x19 cm FOV that allows for thorough examination of tissues. New performance levels allow for targeted diagnoses in a range of disciplines such as orthopaedics, otorhinolaryngology, maxillofacial surgery and dentistry.

Optimal lying down position

The only CBCT system with the patient positioned lying down, a motorized patient table and an open gantry. Considerable reduction of movement-induced artifacts thanks to perfect patient stability at all times.



Specialist software

A revolutionary interface makes image display easier and allows for formulation of an immediate diagnosis. Innovative 3D and 2D analysis functions allow pathologies to be identified quickly and accurately, thus optimising workflows whatever the field of application.

Minimum X-ray doses

EcoScan and SafeBeam™ modes safeguard patient health further by allowing diagnostic examinations to be performed with extremely low X-ray emissions. Native CBCT technology emits effective X-ray doses up to 10 times lower compared to CT, but with better diagnostic quality for bone tissues.

BEST DIAGNOSTIC QUALITY

Unlike its MSCT counterpart, CBCT technology can generate ultra-high definition volumetric images of bone tissues, with "native" isotropic voxel resolution, non-overlapping sections and fewer artifacts. A single cone beam scan instead of a fan beam spiral scan shortens examination times and considerably reduces X-ray exposure with respect to other CT technologies while cutting costs significantly.

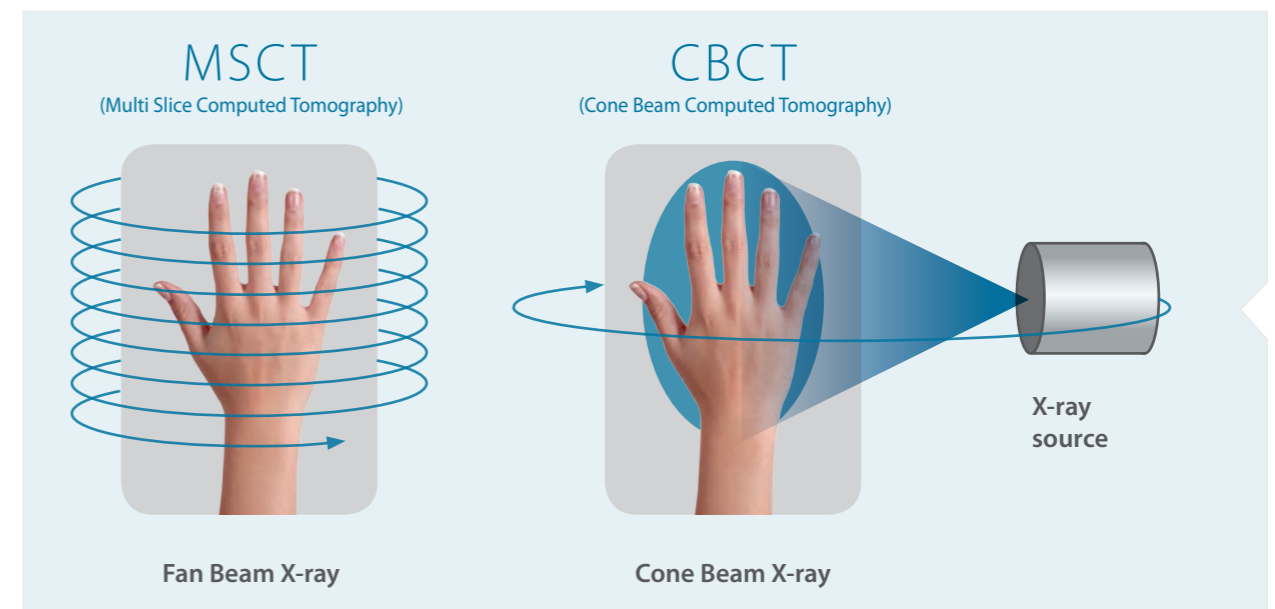

All the elements of the 5G XL come together to provide unprecedented results.

- A new **high power generator with rotating anode** and a small focal spot (0.3 mm) ensures energy emissions are always adapted to specific needs, thus maximising performance.
- A **large flat panel detector** with a high signal-noise ratio improves image quality, broadening 3D and 2D diagnostic capacity and making soft tissues even more homogeneous and discernible.
- **Innovative volumetric reconstruction algorithms** give complete control over the «image chain» while maximising diagnostic potential and minimising artifacts.
- Excellent device accessibility allows **multiple image acquisition protocols**, from Ray2D examinations and joint dynamic studies using the CineX protocol to ultra-high resolution, in-depth 3D bone tissue 1:1-scale examinations.

 The 3D FOV can be set via a field and limited to the zone of interest, measuring Ø6 x h6 cm, up to a native diameter of 21 cm or a height of 22 cm thanks to the **innovative eXtraFOV** function which permits analysis of longitudinal anatomic structures.

 The **HiRes mode** provides images packed with information, essential for highlighting bone micro-fractures and examining anatomical regions with micrometric details.

 **360° scan capacity** allows acquisition of the entire volume with a single rotation, providing a complete dataset of axial, coronal and sagittal images and 3D renderings, suitable for several clinical applications.

The outstanding diagnostic quality of the 5G XL proves useful in multiple medical fields. In addition to examination of dental-maxillofacial pathologies and relative surgical or follow-up planning, it is also possible to examine the internal ear, fully analyse airways and maxillary sinuses and diagnose chronic or traumatic pathologies involving bones, joints and the spinal column for more in-depth orthopaedic investigation, also in emergency rooms.

EXTRA POTENTIAL

Implantology

ENT

Neck

Maxillofacial panoramic

Ray2D

Orthodontics

Knee

Elbow

Foot

Endodontics

TMJ

CineX

The 5G XL extends CBCT technology into multiple fields of application. All-round diagnostic capacity. Unequaled low X-ray doses. eXtra potential to create eXtra value.

ORTHOPAEDIC APPLICATIONS

A scan carried out with the NewTom 5G XL clearly shows all the details of the upper and lower limb joints. The obtained images allow diagnosis of any fractures, dislocations or misalignment. To ensure proper diagnosis and optimal use of time it is possible to begin with a Ray2D examination and then proceed, only where necessary, with 3D assessment of each minimal detail via high resolution volumetric examination. CBCT acquisition allows immediate identification of pathologies not always noticeable using 2D technology (e.g. those involving the metatarsus) as they require dedicated visual alignment or the identification of bone micro-fractures.



3D images can be used for post-surgery follow-up purposes to assess the osseointegration of prostheses, plates and implants and monitor the healing process even where external immobilisation systems such as splints or plaster are in place (elements that obstruct the view on a 2D projection). Compared to a normal CT the longitudinal characteristic of the acquired volume also makes it possible to identify ligament lesions using a radiocontrast agent.

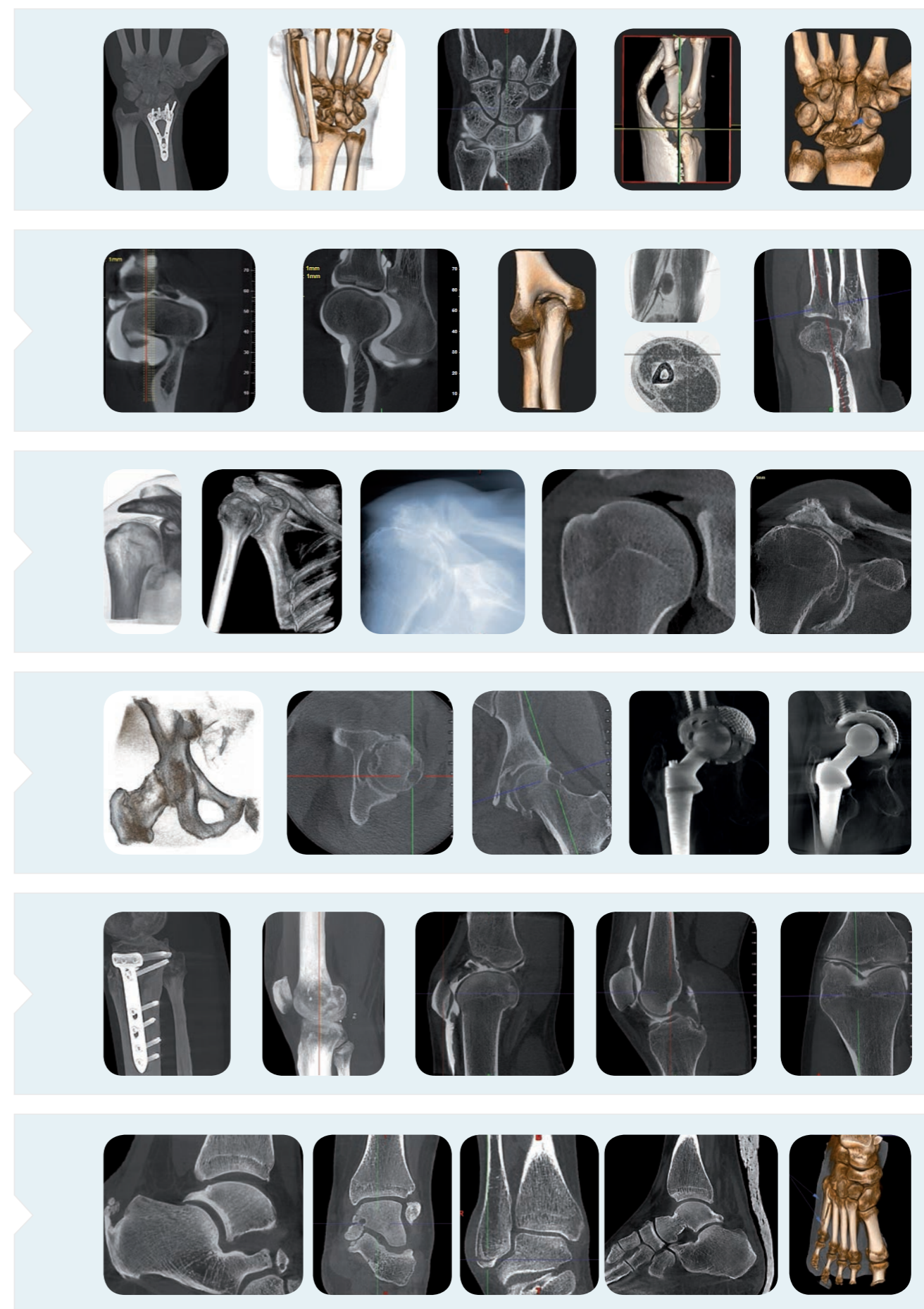

HEAD & NECK APPLICATIONS

Investigating neck pain

Thanks to the improved spatial resolution of CBCT with respect to MSCT, it is possible to clearly view trabecular and cortical structures to identify any dysplastic, inflammatory, traumatic, micro-traumatic or neoplastic elements that may be the source of neck pain. Relationships between vertebral bodies are also perfectly legible, thus highlighting any distortion or subluxation. 3D imaging can also be used to examine the atlanto-occipital joint and in surgical programming for the application of osteosynthesis devices and prosthetics.

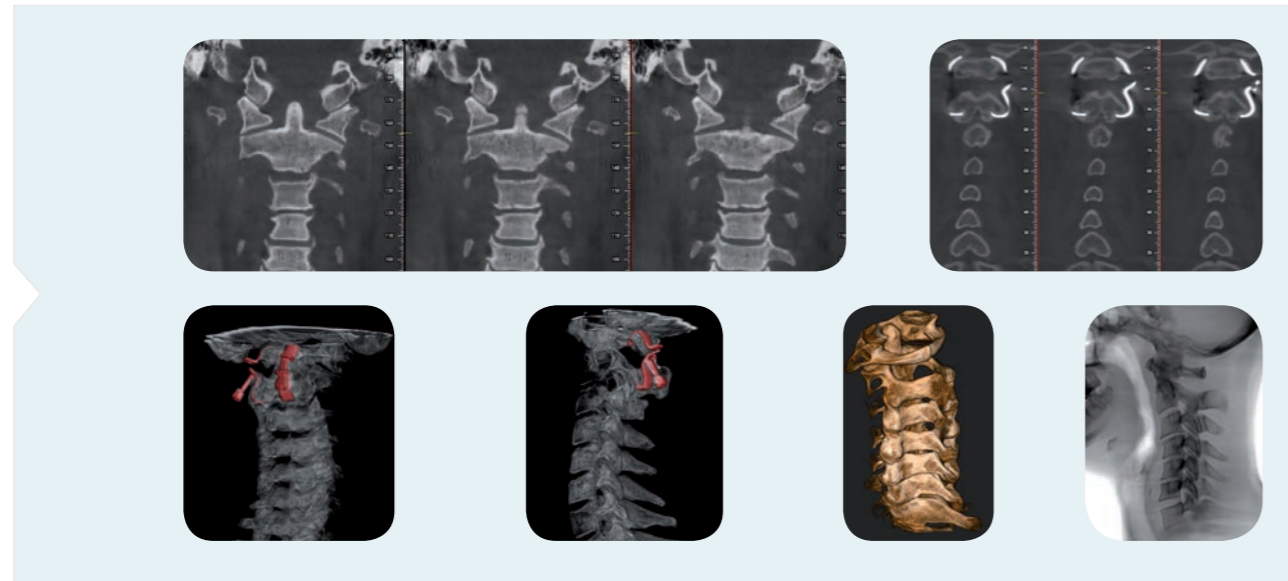

Oral and maxillofacial surgery

The NewTom 5G XL acquires the entire maxillofacial region within a single volume, allowing the characteristics of the area to be examined completely and accurately to verify the presence of fractures or other pathologies, the characteristics of the bone, the dental arches and the impact of dentition and its roots on both the mandibular canal and the maxillary sinuses. This allows surgical treatment to be planned down to the very finest detail. In the event of post-surgery scans, the presence of metallic elements has no impact on image quality as low emission requirements and innovative filters minimise the scattering effect and clearly display the scanned anatomical structures.

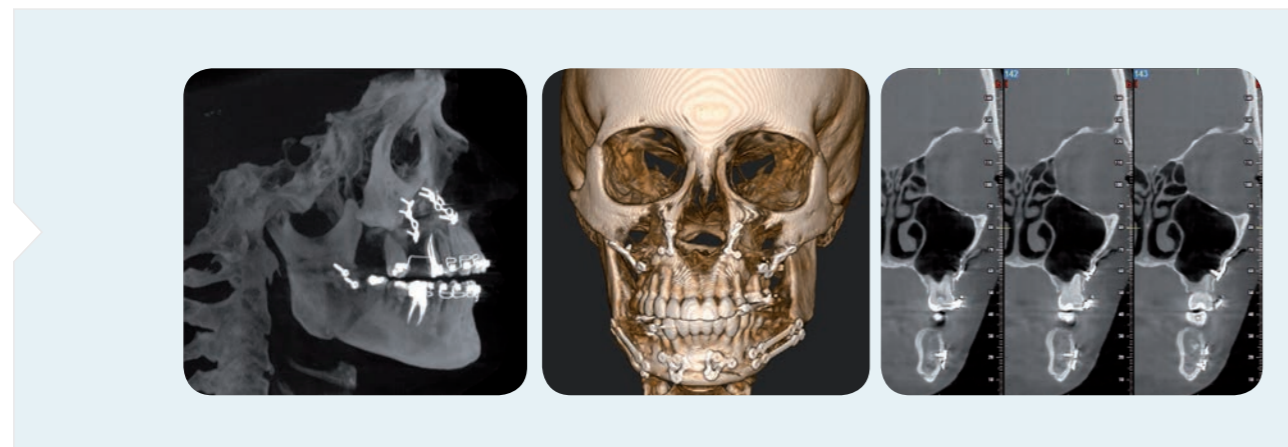

Otorhinolaryngology (ENT)

A single scan with dedicated FOVs allows the user to display all airways, internal ear structures, petrous bones, mastoid bones and paranasal sinuses. Many examinations carried out using conventional MSCT units can also be performed with the NewTom 5G XL which, thanks to improved spatial resolution, provides greater detail. Moreover, utilisation of SafeBeam™ technology ensures patients are not given any unnecessary doses. Various studies have shown that CBCT images can identify correct proper implant positioning at both the round window and the incus with the advantage of exposing the patient to fewer ionizing radiation risks. Consequently, this is preferable as a follow-up method for patients who have had a middle ear implant.

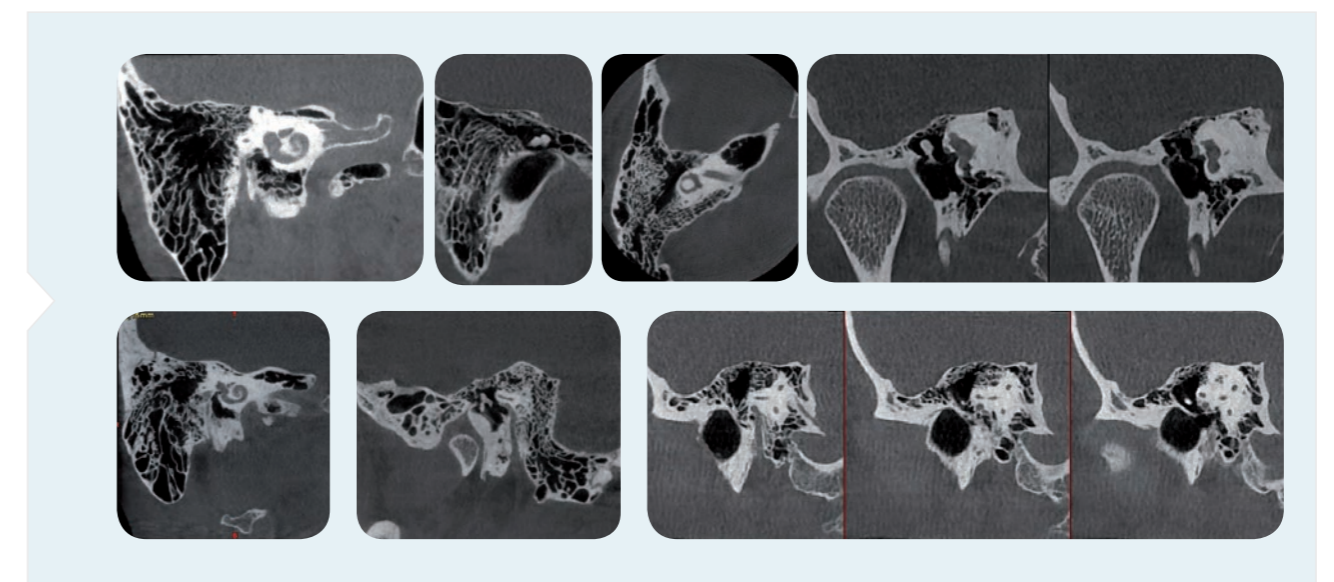
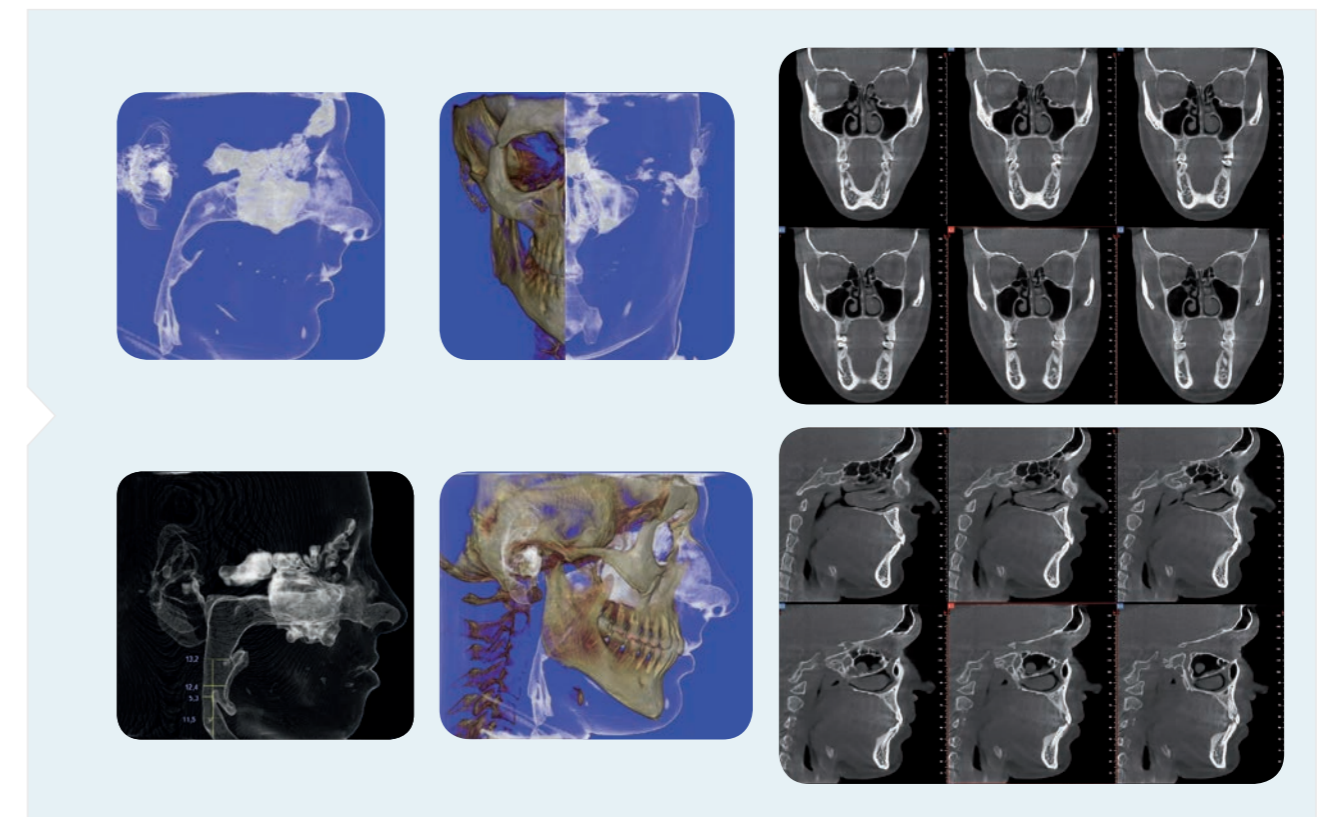

HEAD & NECK APPLICATIONS

Temporomandibular joint examinations (TMJ)

The NewTom 5G XL improves diagnostics on the temporomandibular joint. Sagittal and coronal slices provide optimal imaging of the joint zone and allow identification of any pathologies. 3D rendering images offer outstanding quality and accuracy, thus aiding anatomical assessment of the TMJ and allowing for other key evaluations such as the difference between the height of the condyle and the mandibular branch. By using a radiocontrast agent it is also possible to examine the meniscus.

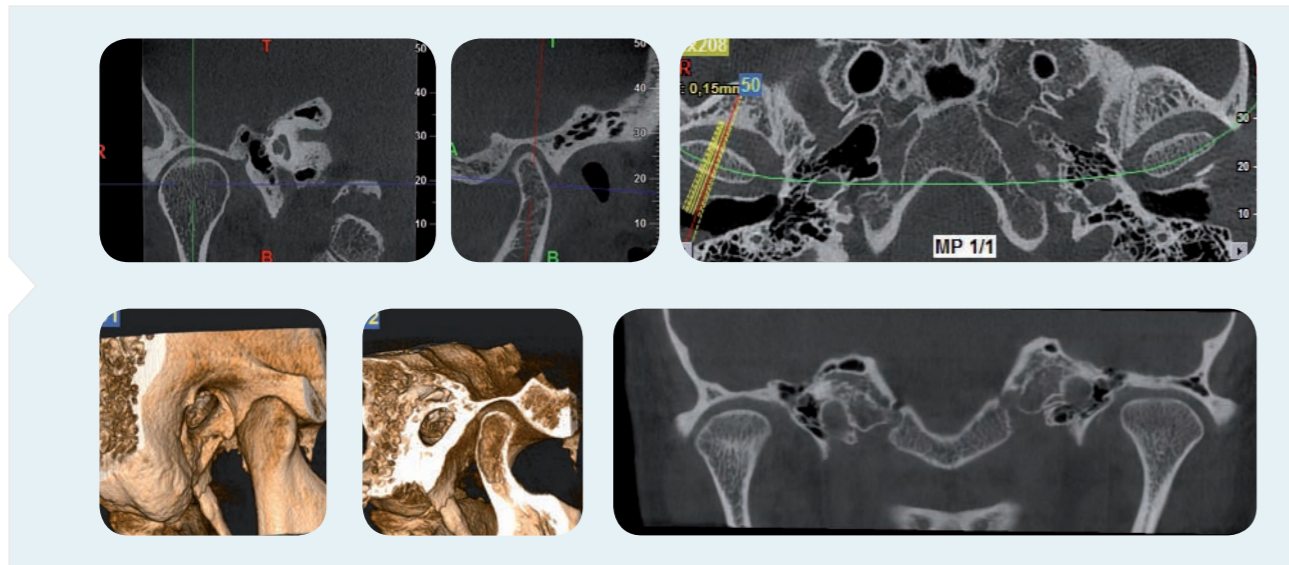

Endodontic and periodontic examinations

CBCCT examination is extremely useful for endodontic therapy or periodontic investigation as it provides images that identify every single detail in the treatment zone, allowing determination of the exact pathology and thorough planning of effective treatment. The 5G XL is particularly effective for assessment of apical lesions, planning of fractured tooth treatment, mandibular canal therapy and treating tissue adjacent to the tooth. The various FOV dimensions confine exposure to the specific region of interest, thus limiting patient X-ray doses.

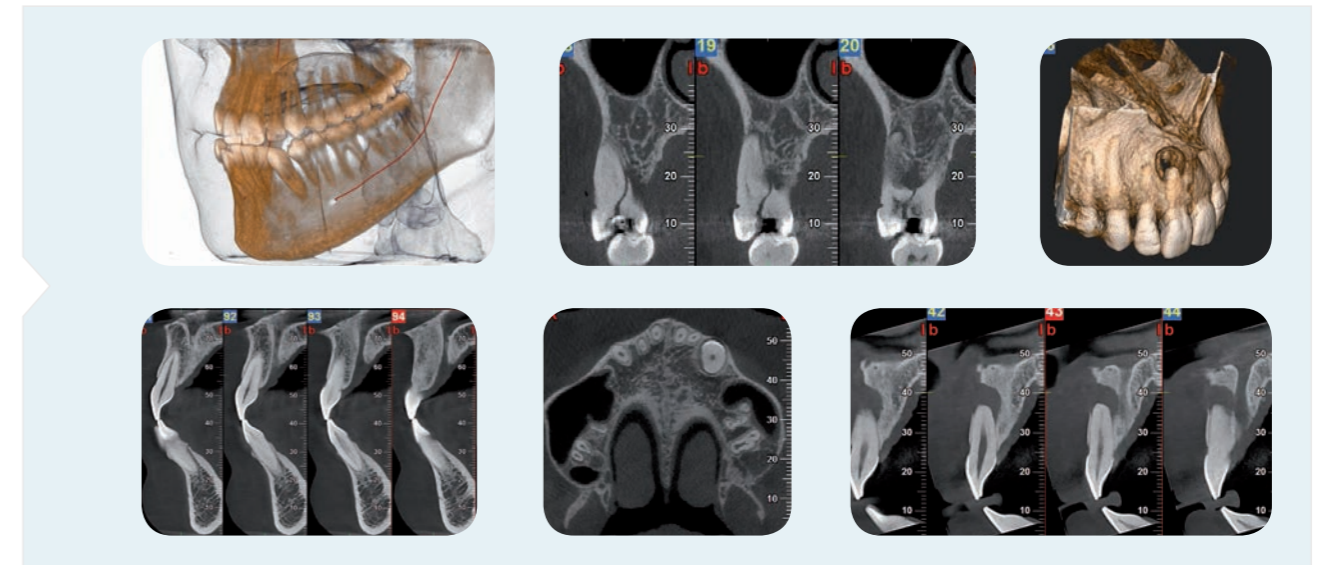

Orthodontic analysis

The NewTom 5G XL is able to produce several types of tomographic, panoramic and cephalometric images in order to execute aesthetic and orthodontic treatment or cure serious pathologies. The 3D image provides a realistic representation of the anatomic region of interest; unlike 2D examination, it is therefore possible to modify the angle of view and adjust the thickness of the reconstructed images to correctly diagnose the reciprocal positioning of the various dental elements and the relationships with surrounding anatomical structures. All these elements are essential for proper planning of treatment, especially in the event of supernumerary and/or impacted teeth.

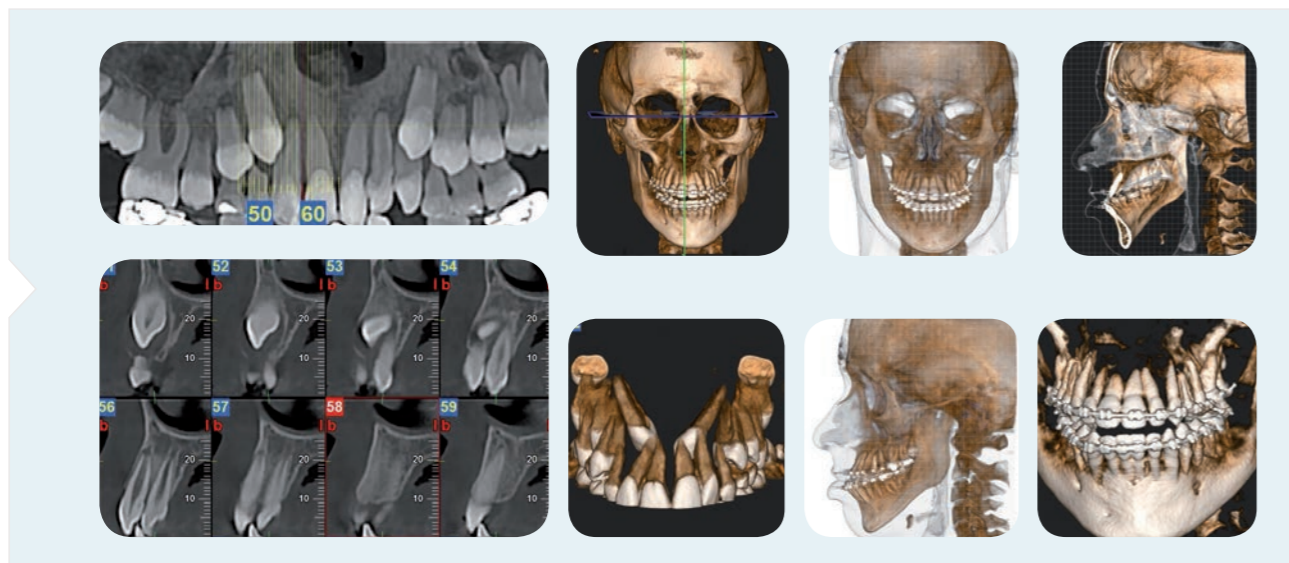

Implant surgery planning

The NewTom 5G XL is an effective implant surgery planning tool. The attained 3D images allow for realistic assessment of the implant site and permit a more accurate choice of the implant type to be used. Information linked to the quality of the surrounding bone and 1:1 scale measurements allow precise definition of implant positioning on the 2D sections and provide 3D rendering simulation. With NIP software it is possible to plan prosthetically guided implant surgery and make the surgical template. Lastly, thanks to low-dosage CBCT examination, follow-up examinations can be made to assess how the osseointegration process is progressing and identify any rejection.

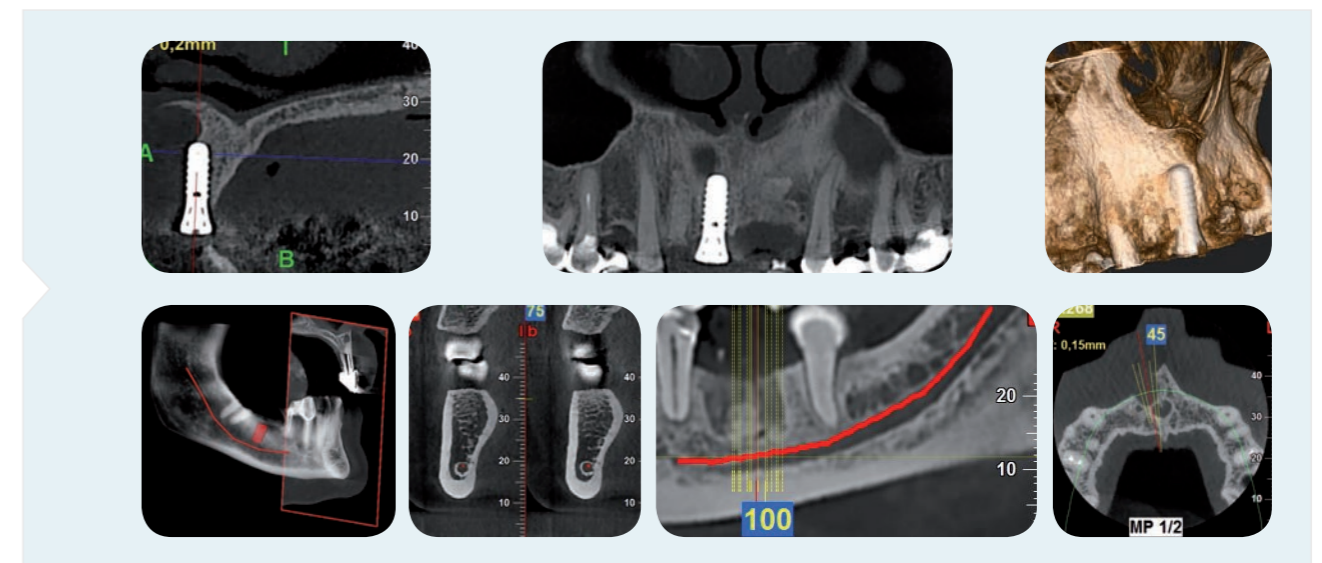

OPTIMAL LYING DOWN POSITION

The NewTom 5G XL is characterised by a **motorized patient table made of carbon fibre**, controlled via a panel on the machine or via the PC. The patient table adapts perfectly to all acquisition requirements, ensuring correct positioning of the patient in a prone or supine, cranial-caudal or caudal-cranial position.



The patient table is ideal for X-raying sedated, post-surgery or traumatised patients, also with a radiocontrast agent. 3D examinations with the patient lying down are particularly suitable for the investigation of pathologies associated with sleep apnea. Reconstructed images are less subject to movement-induced artifacts and examination does not require the use of restraining devices, thus enhancing overall comfort.

The open gantry minimises any sensation of claustrophobia or anxiety. Where the clinical application so requires, it is also possible to carry out examinations with the patient seated on the side opposite the patient table.

This perfect combination of performance ensures maximum results

- The **positioning and lock device** has specifically been designed for the various dental and medical disciplines.
- The **user-friendly control panel** allows for easy 3-axis movement of the patient table, allowing easy patient entry into the scan area.
- The **alignment lasers** activated via the instrument panel provide exact references for the area of interest.
- **Assisted alignment** occurs via the acquisition of two scout images. Correct positioning is ensured by automatic adjustment of the motorized patient table by acting directly on scout images from the workstation.



SPECIALIST SOFTWARE

The software allows **adaptation of the work interface** according to the specific requirements of the radiologist or specialist physician. It is extremely simple to analyse images in compliance with required display standards thanks to dedicated analysis functions.

NewTom's experience in native volumetric reconstruction algorithms and advanced image filters allows optimisation of final quality, reduces artifacts and minimises reconstruction times. All with full control of the diagnostic image.

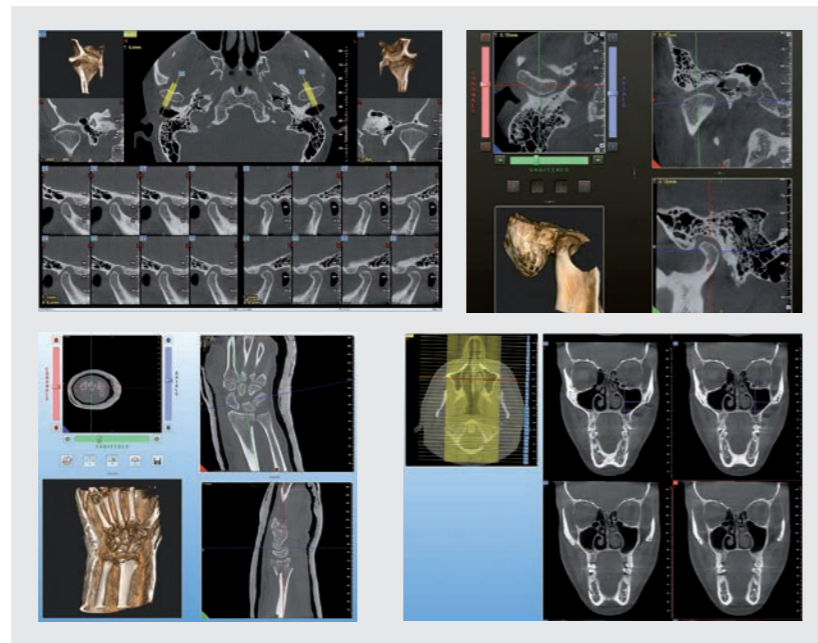

The software can manage and process a vast array of data, from 3D to 2D and X-ray video (CineX).

3D Native CBCT technology allows selection of multiple applicative modes with different FOVs and personalised parameter settings. MPR with 3D Rendering allows user-friendly image analysis. Advanced filters simplify yet strengthen diagnosis and treatment planning. The various software functions include the ability to mark and measure anatomical structures and carry out qualitative tissue analysis. All these functions are particularly useful in dental implant planning applications with pre-loaded libraries.

Ray2D An innovative function that provides 2-dimensional X-ray images measuring 18x19 cm, suitable for initial examination or post-surgery follow-ups. Investigation is possible from various angles. These can be selected prior to examination to obtain an image from an optimal viewpoint.

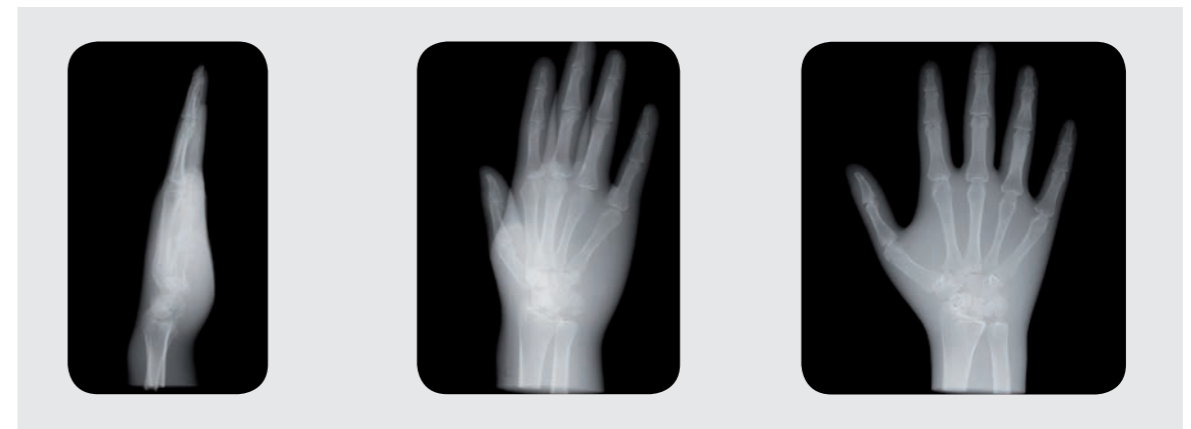

CineX Innovative function characterised by the dynamic acquisition of a sequence of X-ray images stored as video; this allows for the investigation of moving anatomical structures. Thanks to an 18x19 cm on-patient filming area, CineX can be used to study salivary ducts and joint mobility. Special software allows users to select the acquisition time and check alignment of the region of interest via a scout image.

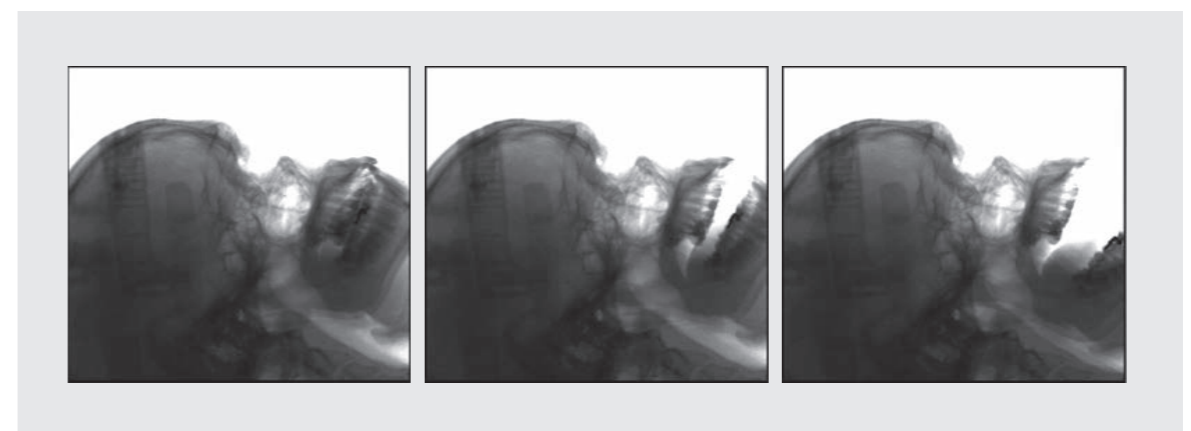

TOTAL CONNECTIVITY

Both 3D and 2D images, and the CineX function, can be distributed using the NNT Viewer software version or printed in 1:1 scale to produce personalised reports. Compatibility with other surgical planning and surgical navigation software and hospital management systems is always guaranteed by the DICOM 3.0 interface (IHE).

MINIMUM X-RAY DOSES

CBCT technology ensures X-ray doses up to 10 times lower than those emitted by MSCT, with better diagnostic quality on bone tissues. A dose comparable to two 2D X-rays (AP and LL) generally needed for an initial examination.

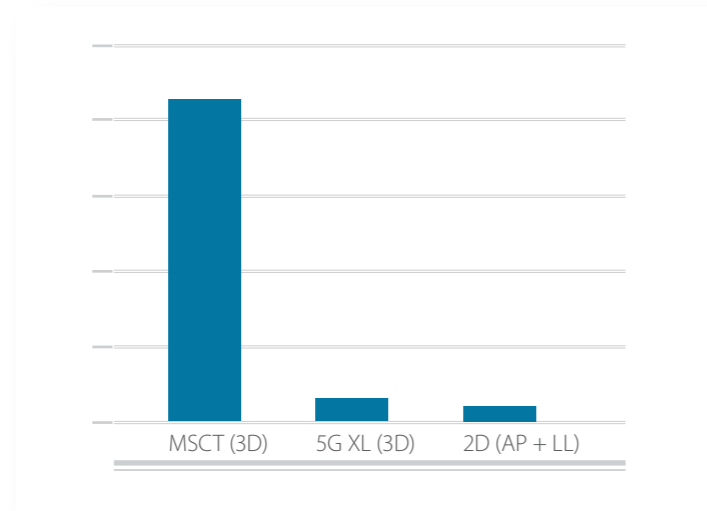

Patient well-being is central to all NewTom developments.

That's why the 5G XL device combines ever-better diagnostic quality with the lowest X-ray emissions, providing performance of undisputed excellence.

- The **high power generator** allows higher filtration, providing protection from the more harmful low-energy radiation.
- X-ray emission occurs in **pulsed mode** during the scan for an extremely limited time, from a minimum of 0.9 s to a maximum of 5.4 s.
- Lastly, **variable collimation** limits exposure to the regions of interest.



ECOScan. Low emissions scan protocol for post-surgery follow-ups and paediatric applications. Emissions reduced to just 1.4 seconds in the case of a standard examination.



SafeBeam™. Technology that automatically adapts emissions to the patient's build, eliminating the possibility of overestimated doses while ensuring maximum quality at all times.



Ray2D. Function that allows the investigation to begin with a low-dose 2D X-ray examination and then proceed, only where in-depth information is required, with a high resolution 3D examination of the specific region of interest.

TECHNICAL SPECIFICATIONS

X-Ray Source	High frequency generator, rotating-anode X-ray tube			
Focal spot	0.3 mm			
Exposure Control	SafeBeam™ to reduce exposure according to patient build			
Detector	Amorphous silicon flat panel			
Signal grey scale	16-bit			
3D scan time	18s (typical)			
3D emission time	0.9 s to 5.4 s (single scan)			
3D image acquisition	Single scan with Cone Beam technology. 360° rotation			
Available FOV DxH	Selectable 3D scan modes			
	Standard	HiRes	Eco	Boosted
21 x 19 cm	•		•	•
18 x 16 cm	•		•	•
15 x 22 cm eFOV	•		•	•
15 x 12 cm	•		•	•
15 x 5 cm	•	•	•	•
12 x 8 cm	•	•	•	•
10 x 10 cm	•	•	•	•
10 x 5 cm	•	•	•	•
8 x 8 cm	•	•	•	•
8 x 5 cm	•	•	•	•
6 x 6 cm	•	•	•	•
Selectable voxel size - Standard	200 to 300 µm			
Selectable voxel size - HiRes	100 to 150 µm			
Reconstruction time	Less than 1 minute			
Image acquisition Ray2D	Digital Radiography (single shot, position selectable by user)			
CineX image acquisition	1-36s Serial Radiography, field of view 18 x 19 cm (W x H)			
Patient positioning	Seated or lying down, prone or supine, in cranial-caudal or caudal-cranial position			
Weight	660 Kg			
Software	NNT			
Power supply	15A @100/115 V~, 12A @200 V~, 10 A @220/230 V~, 8A @240 V~, 50/60 Hz			

Specifications subject to change without prior notice.

NETWORK CONFIGURATION

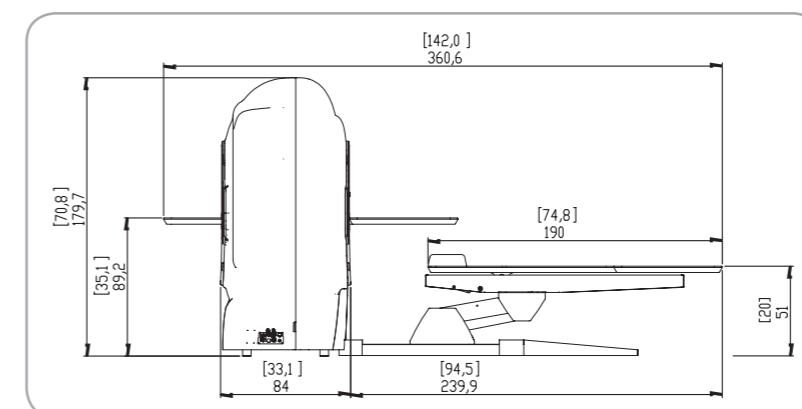
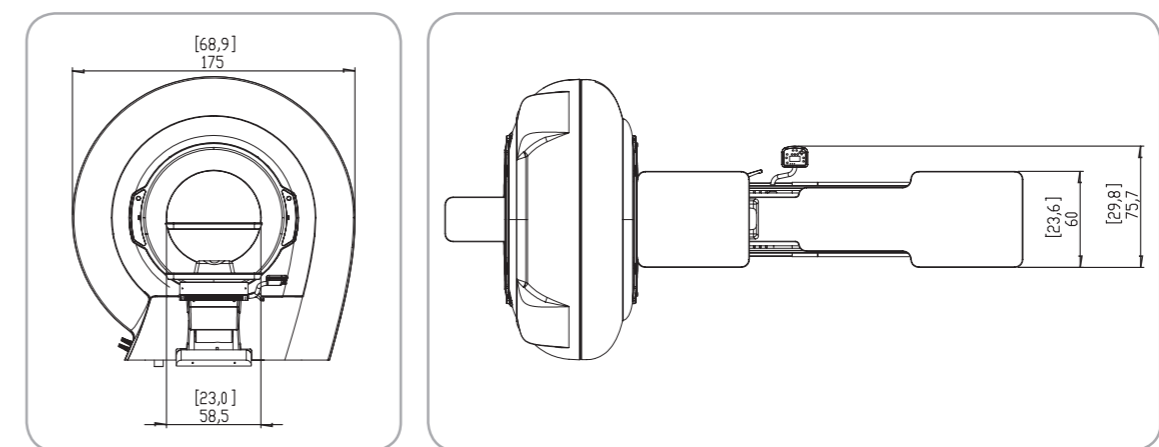
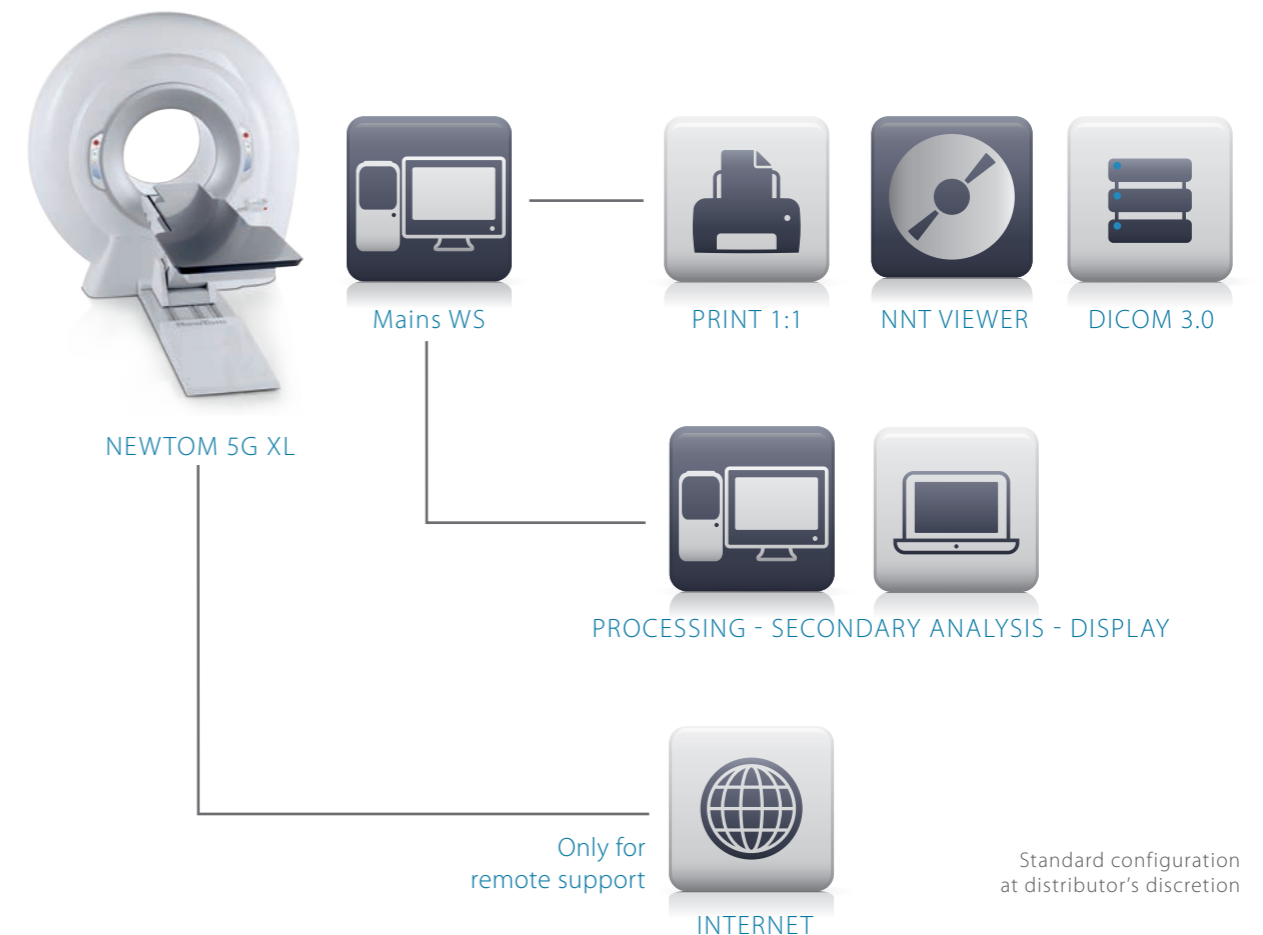

Dimensions in centimetres
(dimensions in inches)

